

RELIABLE AUTOMOTIVE CONNECTIONS

HSD / FAKRA / Custom solutions

- » Excellent mounting and interconnection security
- » Outstanding signal integrity in RF or digital applications
- » Sophisticated mechanical and colour-coded system
- » Perfect performance all the time, no matter if coaxial or digital transmission





1.	IMS CONNECTOR SYSTEMS – THE COMPANY	3
2.	INNOVATIVE RF-INTERFACES FROM IMS CONNECTOR SYSTEMS	6
	SMART ANTENNAS	7
	HEAD AND CONTROL UNITS	8
	RUGGEDIZED DEVICES IN HARSH ENVIRONMENTS	9
3.	HSD CONNECTORS	10
	APPLICATIONS AND PRODUCT CHARACTERISTICS	10
	CODING	11
	FAMILY SPECIFICATION	12
	PRODUCTS	14
4.	SMBA® (FAKRA) CONNECTORS	18
	APPLICATIONS AND PRODUCT CHARACTERISTICS	18
	YOUR BENEFITS	19
	CODING	20
	FAMILY SPECIFICATION	21
	PRODUCTS	24
	TOOLS	32
5.	IMS CONNECTOR SYSTEMS – WORLDWIDE	34

SMBA® is a registered trademark of IMS Connector Systems, Germany.

While the information has been carefully compiled to the best of our knowledge, nothing is intended as representation or warranty on our part and no statement herein shall be constructed as recommendation to infringe existing patents.

IMS CONNECTOR SYSTEMS – IN GOOD HANDS

In 1863 Johann Morat founded a company in Eisenbach in the Black Forest which focused on the development of machines to produce gear wheels and axles for mechanical clocks. It was a customer's request that resulted in IMS manufacturing radio frequency (RF) connectors and cable assemblies. The connector division, which began in earnest in 1972, was so successful that it became an independent company in 1989.

Today IMS Connector Systems is an international, technology driven company, specializing in development and manufacturing of radio frequency connections. The product range includes a large assortment of coaxial RF connectors, coaxial cable assemblies, RF antenna switches and custom design connectors for M2M and IoT applications. Our Portfolio also includes the innovative Quick Lock connectors, SnapN, Med-EasyLock and the newly developed 4.3-10 connector series.

For automotive applications IMS CS provides the connector series SMBA®, complying with the standard for a uniform connector system established by FAKRA (Automotive Expert Group). In addition we are able to offer our extensive High Speed Data (HSD) portfolio. Essential for the success of IMS CS is our orientation to customers and markets, individual technical support worldwide, continuous innovation and high quality standards.

Furthermore IMS CS owns high competence and experience in research and development. We offer our customers customized RF solutions for individual applications.

Applications:

- » Automotive
- » Antennas
- » Communication
- » Industrial
- » Instrumentation
- » Medical equipment
- » M2M and IoT applications
- » Transportation



RESEARCH & DEVELOPMENT

IMS Connector Systems is an international technology company with a strong research and development division. We offer customized radio frequency (RF) solutions for individual applications. Through close cooperation between Product Management and Sales, our specialists - mechanical design and signal integrity - realize many innovative developments, which are oriented to the requirements of our markets.

Highly qualified employees as well as the latest methods and procedures in development and manufacturing only account for some of our success. A further decisive success factor is the close cooperation with our customers, ensuring that we are always able to find the best customer-oriented solution in each research and development project.

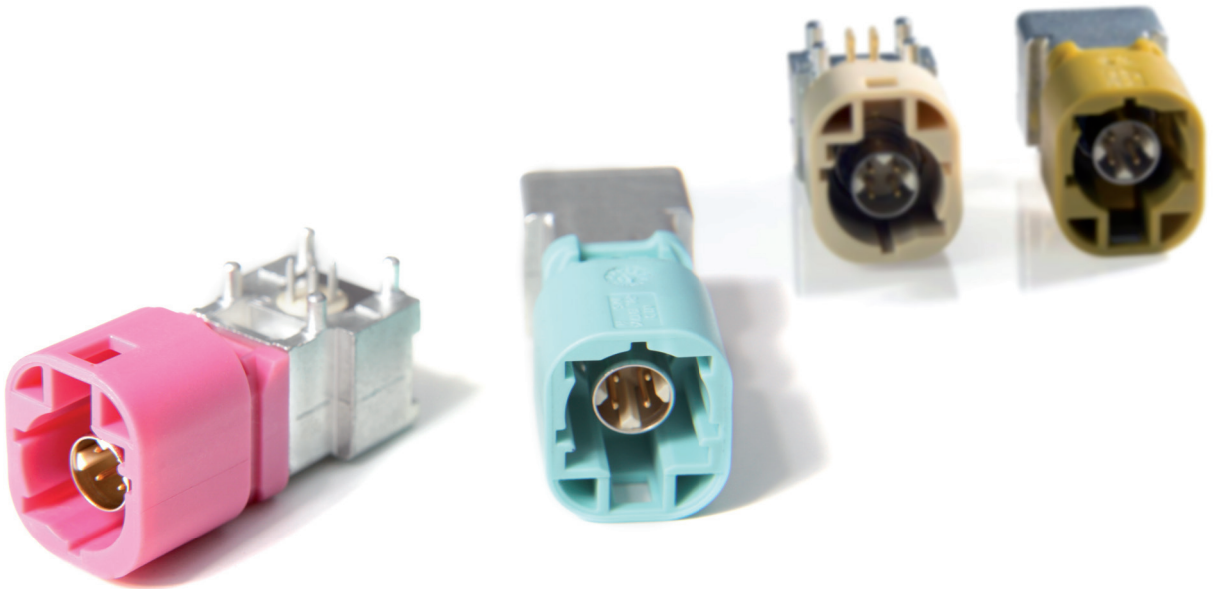

Innovation through intensive research

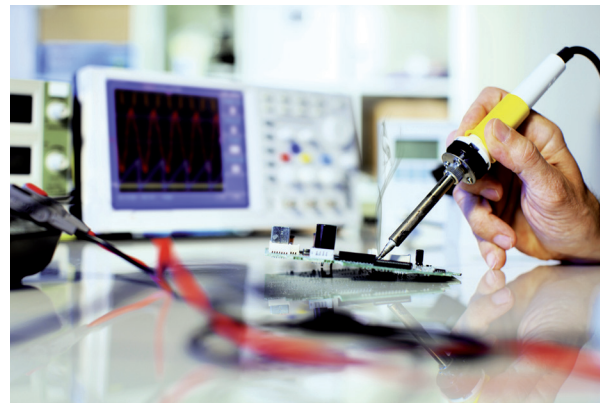

Development of customized RF solutions

ECONOMIC, EFFICIENT AND HIGH QUALITY PRODUCTION

For decades now we have been fulfilling our customers' needs for impeccable quality, favourable prices and reliable service. For this reason, we select our manufacturing sites according to the requirements which are best suited to our products. We have pursued this strategy for years; our factories in China, in operation since 1999, and Hungary, established in since 1997, each with their stable core of employees, are guarantors of the highest possible process quality. We achieve speed and flexibility through our modern, lean production and assembly facilities – and our highly qualified employees. Myriad connectors and connector systems, cables and wires of every description, special materials and technologies of all sorts can be processed in our automated systems, to guarantee an optimized product, delivered right on time.

Depending on the product and batch size, we offer various possibilities for assembly: automatic and semiautomatic assembly lines, manual assembling, cable assembling.

IMS CS is renowned for its high quality products and services. We implement the most effective quality assurance methods like Design FMEA (Failure-Mode-Effect-Analysis), Process FMEA, Logistics FMEA, DoE (Design of Experiments), and SQP (Supplier quality planning). IMS CS is certified according to ISO 9001, IATF 16949, ISO 14001 and OHSAS 18001.



Full automatic HSD feeding

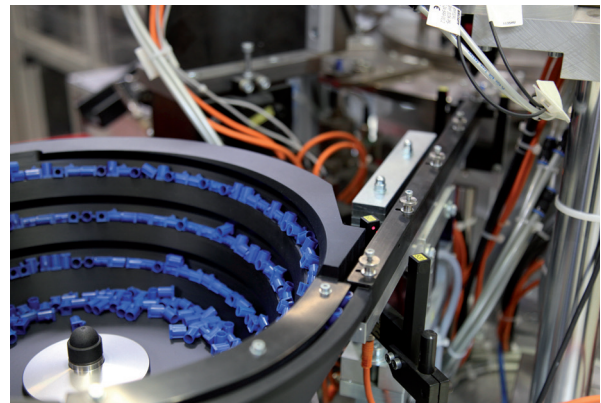

Full automatic SMBA® (FAKRA) feeding

INNOVATIVE RF INTERFACES FROM IMS CONNECTOR SYSTEMS

Radio frequency (RF), High Speed Data, miniaturization, multipol or watertightness...
No matter what your requirement looks like, we offer YOUR tailor-made solution...

Technological competence and product quality: With these, we are creating customer-specific innovations and future-oriented connection systems for the automotive industry. In our innovation center we solve even the most demanding interconnection challenges, delivering extreme signal integrity and reliability in the harshest environmental conditions,

through our broad and growing portfolio of product technologies. The intensive collaboration of our automotive experts in engineering, project management, and customer service – in close cooperation with our customers – guarantees optimal coordination of all development processes for customer-driven design-in projects.

INNOVATIVE RF INTERFACES FROM IMS CONNECTOR SYSTEMS

2

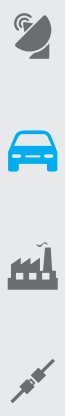

SMART ANTENNAS

RUGGED DEVICES IN HARSH ENVIRONMENTS

HEAD AND CONTROL UNITS

CUSTOMIZED BOARD TO BOARD RF SOLUTIONS FOR SMART ANTENNAS

- » Small and reliable
- » Superior RF performance up to 6 GHz
- » Excellent compensation of axial and radial misalignment
- » Scalable multi-pole connections
- » Very low mounting height
- » Hybrid RF & LF signal combination
- » Optimized footprints & SMT solder capable
- » Various mating design solutions in „X“ or „Z“ direction

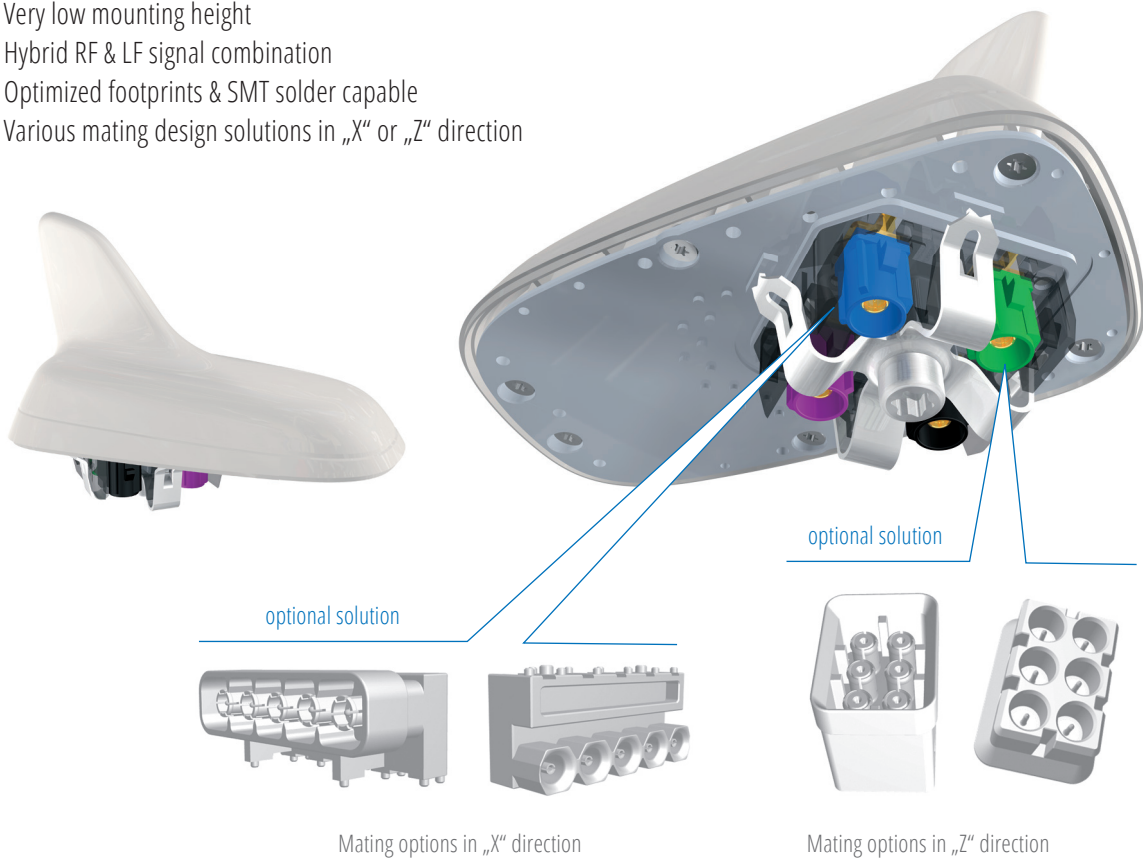

CUSTOMIZED MINIATURE MULTI-POLE RF SOLUTIONS FOR HEAD AND CONTROL UNITS

- » Compact design solutions
- » High speed data transmission up to 20 Gbit/s
- » Excellent radio frequency (RF) performance up to 15 GHz
- » Scalable multi-pole connections
- » Hybrid RF & LF signal combination
- » Optimized footprints & SMT solder capable

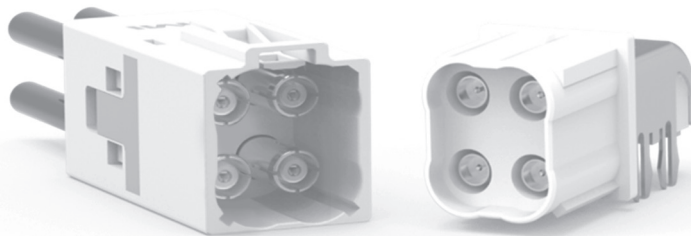

Head and control units

CUSTOMIZED WATERTIGHT RF SOLUTIONS FOR RUGGEDIZED DEVICES IN HARSH ENVIRONMENTS

- » IPX9K and IP68 watertight customized solutions
- » Superior RF performance up to 6 GHz
- » Various device sealing adaption feasible for FAKRA interface acc. ISO 20860-1 or customized interfaces
- » Highest protection against steam-jets for automotive applications
 - antennas in bumpers
 - camera systems

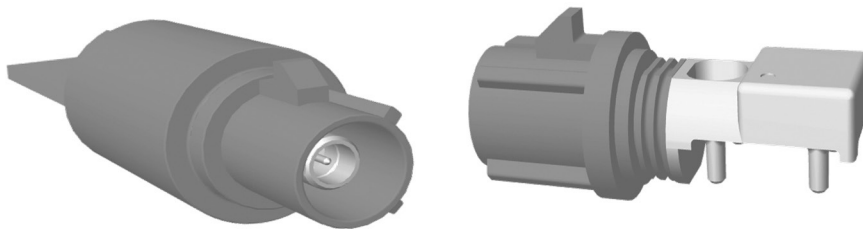

Watertight park distance control

HIGH SPEED DATA CONNECTORS: BIG DATA SOLUTIONS

Newly developed, the digital HSD plug connector system enables excellent data transfer through LVDS signals (Low Voltage Differential Signaling). The optimised, impedance adapted plug connector system offers a first-class transfer quality; external sources of interference and crosstalk are prevented.

The main product characteristic SSR (smart strain relief), an intelligent strain relief unit, leaves the soldering points free of strain in circuit board connections. Together with the feeding V-belt in the mating area it creates extraordinary mechanical mating security and robustness.

Applications

- » Infotainment
- » HD-entertainment
- » Driver assistance
- » Telematics
- » LVDS-camera
- » GVIF-video transmission
- » IEE 1394, USB, Ethernet-data connections
- » More 100 ohm „high speed data“ connectors

Product Characteristics

- » SSR enables unstressed solder joints for PCB types
- » Tilt safety
- » High data bit rate up to 5 Gbit/s
- » Excellent resistance against cross-talk and RF EMC
- » Mechanical robustness according to automotive requirements
- » THR and THT capable for automated assemblies
- » Mechanical and colour coding prevents mismatching
- » Primary and secondary locking mechanism ensures highest interconnection security



Big Data in headunits













Your fast HSD connector series

INTELLIGENT MOUNTING BY COLOUR CODING SYSTEM

HSD connectors are equipped with a standardised coding system which permits easy and fast assembly using fourteen possible codings. The locking system with primary and secondary locking

guarantees highest reliability of assembly and contact. High speed data connectors enable excellent data transfer of LVDS signals.

Jack	Cable left, down, right	Colour	RAL-number	Coding	Plug
		Jet black	9005	A	
		Cream	9001	B	
		Signal blue	5005	C	
		Claret violet	4004	D	
		Leaf green	6002	E	
		Nut brown	8011	F	
		Water blue	5021	Z	
Jack	Cable up	Colour	RAL-number	Coding	Plug
		Blue grey	7031	G	
		Heather violet	4003	H	
		Beige	1001	J	
		Curry	1027	K	
		Yellow green	6018	L	
		Pastell orange	2003	M	
		Light green	6027	O	

The colours of the plastic housing are based on RAL colour codes. Slight colour variations during the production process are possible.

HSD – FAMILY SPECIFICATION

Electrical characteristics	
Characteristic impedance	100 +/-10% Ohm
Operating frequency	up to 2 GHz
Return loss (typical)	at 1 GHz: ≥ 20dB; at 2 GHz: ≥ 17dB
RF Leakage	up to 1GHz: ≥ 75dB; up to 2 GHz: ≥ 65dB
Insertion loss	≤ 0.1 dB
Insulation resistance	≥ 1x10 ³ mOhm
Center contact resistance	≤ 10 mOhm
Outer contact resistance	≤ 7.5 mOhm
Contact current max. (DC)	≤ 1.5 A DC
Operating voltage	max. 100 V DC
Proof voltage	min. 250 V eff.
Nearend crosstalk	≤ 33 dB
Farend crosstalk	≤ 28 dB
Skew (between signal contacts)	≤ 20 psec (angle version)
Mechanical characteristics	
Engagement force (typical)	≤ 30 N
Separating force (typical)	≥ 5 N
Mating cycles	≥ 25
Coding efficiency	≥ 80 N
Retention force locked system	≥ 110 N
Materials	
Outer contact - Male - Female	Brass
Centre contact - Male - Female	Brass or equivalent
Plastic housing	PA or equivalent
Other metal parts	Zinc alloy
Insulator	LCP
Cap	Zinc alloy
Standard plating	
Outer contact - Male - Female	Ni 3-6 µm Ni 3-6 µm
Centre contact - Male - Female	Au min. 0.15 µm Au min. 0.15 µm
Plastic housing	-
Other metal parts	Cu + Ni + Tin plated
Insulator	-
Cap	Cu + Ni
Environmental influences	
Operating temperature range	-40°C up to +105°C
Thermal shock	DIN IEC 60068-2-14 Test NA
Temperature and humidity	USCAR 2-4 5.6.2
Vibration (Random)	DIN IEC 60068-2-64
Mechanical shock	DIN IEC 60068-2-27
High-Temp. exposure	DIN IEC 60068-2-2
Solder profile	IEC 60068-2-58 Group 3&4



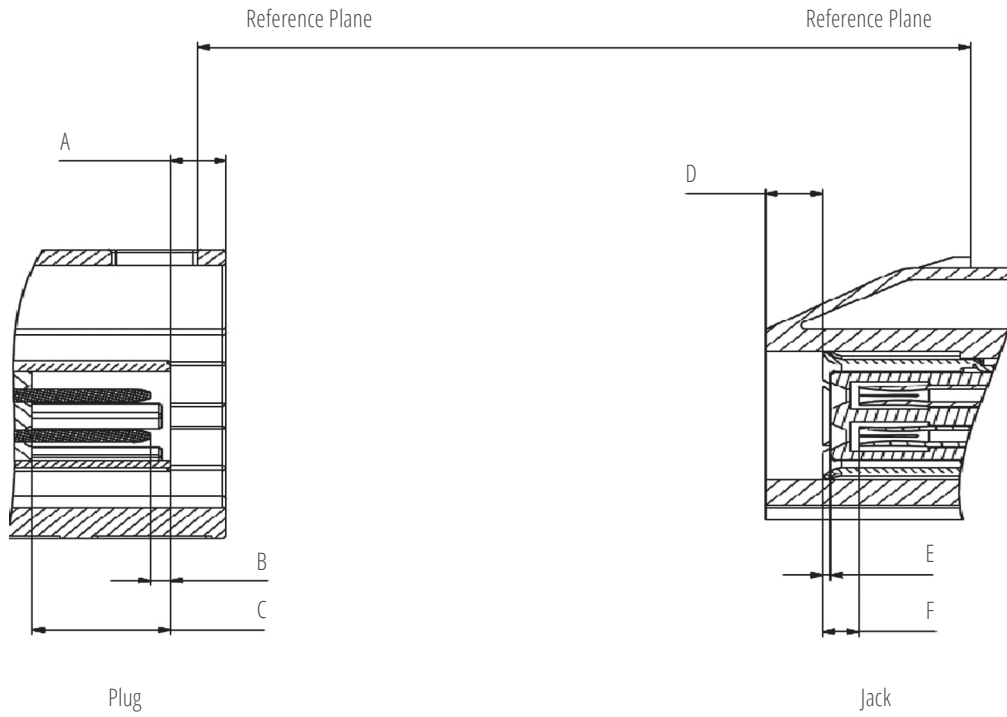

	Plug (mm)		Jack (mm)	
	min.	max.	min.	max.
A	1.95	2.25		
B	0.45	1.1		
C	5.2	5.45		
D			2	2.27
E			0.2	0.45
F			1.02	1.67

IMS Connector Systems connectors fulfill in principle the indicated technical data. Individual values of the connectors may deviate depending on applications, design, cable types and assembly methods.

Specific product data sheets for particular products can be provided on request from your IMS CS sales contact.

HSD – PCB mount plug (m) 100 ohm
HSD – Anbaustecker (m) 100 Ohm

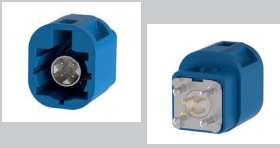

Packing Unit	Verpackungseinheiten
Coding HSD	Kodierung HSD
230 in Tape & Reel	230 in Tape & Reel
A,B,C,D,E,F,Z + 0	A,B,C,D,E,F,Z + 0
Features	Merkmale
THD – Through hole device	Durchsteckmontage
THR – Reflow soldering capable	THR – Reflow lötfähig

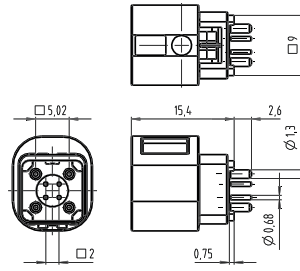

Part No.
Artikel-Nr.

5112.HSD.1X10.00 9

Please note: Change the X for your required coding (page 11)
Bitte beachten: Das X durch Ihre gewünschte Kodierung ändern (Seite 11)

Plating
Oberflächenausführung

9 = Ni

Other platings on request
Andere Oberflächen auf Anfrage

HSD – PCB mount plug (m) 100 ohm
HSD – Anbaustecker (m) 100 Ohm



Packing Unit	Verpackungseinheiten
Coding HSD	Kodierung HSD
on request	auf Anfrage
A,B,C,D,E,F,Z	A,B,C,D,E,F,Z
Features	Merkmale
SSR (Smart Strain Relief)	Intelligente Kabelzugentlastung
THD – Through hole device	Durchsteckmontage
THR – Reflow soldering capable	THR – Reflow lötfähig

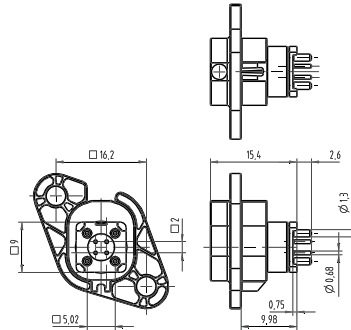

Part No.
Artikel-Nr.

5007.HSD.1X10.00 9 OUTLOOK

Please note: Change the X for your required coding (page 11)
Bitte beachten: Das X durch Ihre gewünschte Kodierung ändern (Seite 11)

Plating
Oberflächenausführung

9 = Ni

Other platings on request
Andere Oberflächen auf Anfrage

HSD – PCB mount plug (m) + 2 MQS Power Pins 100 ohm
HSD – Anbaustecker (m) + 2 MQS Power Pins 100 Ohm

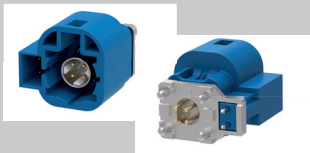

Packing Unit	Verpackungseinheiten
Coding HSD	Kodierung HSD
150 in Tape & Reel	150 in Tape & Reel
A,B,C,D,E,F,Z	A,B,C,D,E,F,Z
Features	Merkmale
4 signal + 2 power pins	4 Signal + 2 Power Pins
THD – Through hole device	Durchsteckmontage
THR – Reflow soldering capable	THR – Reflow lötfähig

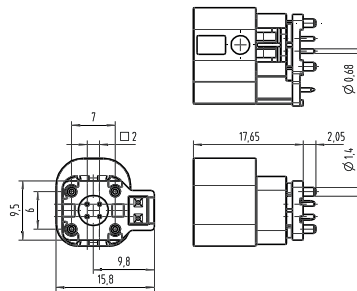

Part No.
Artikel-Nr.

5001.HSD.1X10.00 9

Please note: Change the X for your required coding (page 11)
Bitte beachten: Das X durch Ihre gewünschte Kodierung ändern (Seite 11)

Plating
Oberflächenausführung

9 = Ni

Other platings on request
Andere Oberflächen auf Anfrage



HSD – PCB mount angle plug (m) 100 ohm
HSD – Anbauwinkelstecker (m) 100 Ohm

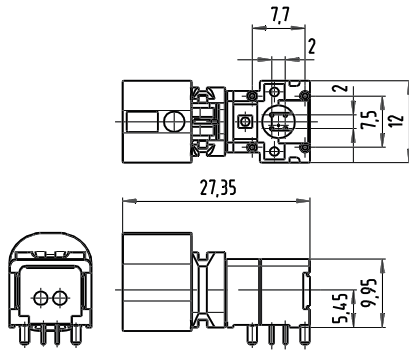

Packing Unit	Verpackungseinheiten
Coding HSD	Kodierung HSD
80 in Tray	80 in Tiefziehverpackung
A,B,C,D,E,F,Z + G,H,J,K,L,M,O	A,B,C,D,E,F,Z + G,H,J,K,L,M,O
Features	Merkmale
THD – Through hole device	Durchsteckmontage
THR – Reflow soldering capable	THR – Reflow lötfähig

Part No.
Artikel-Nr.
5185.HSD.1X10.00 9

Please note: Change the X for your required coding (page 11)
Bitte beachten: Das X durch Ihre gewünschte Kodierung ändern (Seite 11)

Plating
Oberflächenausführung
9 = Ni
Other platings on request
Andere Oberflächen auf Anfrage

HSD – PCB mount angle plug (m) 100 ohm
HSD – Anbauwinkelstecker (m) 100 Ohm

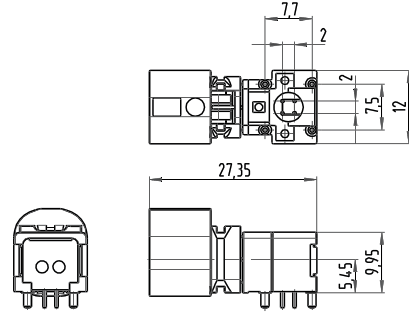
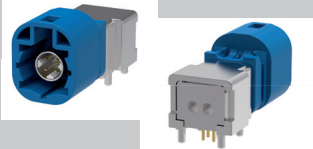

Packing Unit	Verpackungseinheiten
Coding HSD	Kodierung HSD
80 in Tray, 200 in Tape & Reel	80 in Tiefziehverpackung, 200 in Tape & Reel
A,B,C,D,E,F,Z + G,H,J,K,L,M,O	A,B,C,D,E,F,Z + G,H,J,K,L,M,O
Features	Merkmale
SSR (Smart Strain Relief)	Intelligente Kabelzugentlastung
THD – Through hole device	Durchsteckmontage
THR – Reflow soldering capable	THR – Reflow lötfähig

Part No.
Artikel-Nr.
4936.HSD.1X10.00 9

Please note: Change the X for your required coding (page 11)
Bitte beachten: Das X durch Ihre gewünschte Kodierung ändern (Seite 11)

Plating
Oberflächenausführung
9 = Ni
Other platings on request
Andere Oberflächen auf Anfrage

HSD – PCB mount angle plug (m) + 2 MQS Power Pins 100 ohm
HSD – Anbauwinkelstecker (m) + 2 MQS Power Pins 100 Ohm

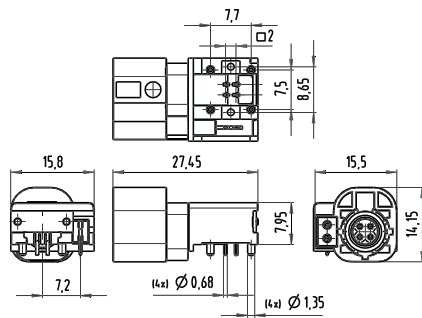
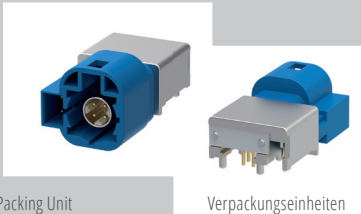

Packing Unit	Verpackungseinheiten
Coding HSD	Kodierung HSD
on request	auf Anfrage
A,B,C,D,E,F,Z	A,B,C,D,E,F,Z
Features	Merkmale
4 signal + 2 power pins	4 Signal + 2 Power Pins
THD – Through hole device	Durchsteckmontage
THR – Reflow soldering capable	THR – Reflow lötfähig

Part No.
Artikel-Nr.
5283.HSD.1X10.00 9 OUTLOOK

Please note: Change the X for your required coding (page 11)
Bitte beachten: Das X durch Ihre gewünschte Kodierung ändern (Seite 11)

Plating
Oberflächenausführung
9 = Ni
Other platings on request
Andere Oberflächen auf Anfrage

HSD – Cable mount plug (m) 100 ohm
 HSD – Kabelstecker (m) 100 Ohm

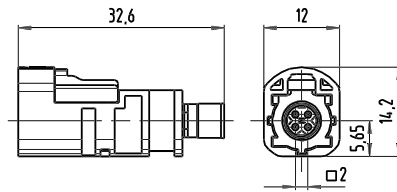
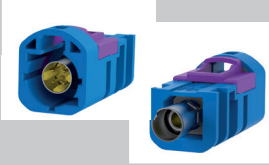

Part No. Artikel-Nr.	Cable Group Kabelgruppe
7309.HSD.1X10.0R	9 R (Dacar 535, 4-pole)

- Please note:
- Change the X for your required coding (page 11)
 - As cable assembly available
- Bitte beachten:
- Das X durch Ihre gewünschte Kodierung ändern (Seite 11)
 - Als Kabelkonfektion verfügbar

Packing Unit Coding HSD	Verpackungseinheiten Kodierung HSD
on request	auf Anfrage
A,B,C,D,E,F,Z	A,B,C,D,E,F,Z

Plating Oberflächenausführung
9 = Ni
Other platings on request Andere Oberflächen auf Anfrage

HSD – Cable mount jack (f) 100 ohm
 HSD – Kabelbuchse (f) 100 Ohm

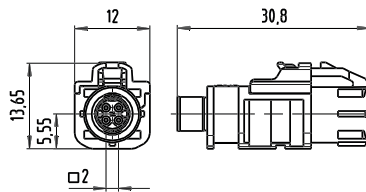
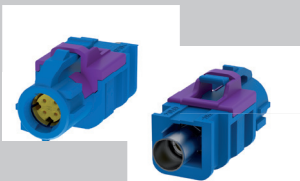

Part No. Artikel-Nr.	Cable Group Kabelgruppe
7308.HSD.2X10.0R	9 R (Dacar 535, 4-pole)

- Please note:
- Change the X for your required coding (page 11)
 - As cable assembly available
- Bitte beachten:
- Das X durch Ihre gewünschte Kodierung ändern (Seite 11)
 - Als Kabelkonfektion verfügbar

Packing Unit Coding HSD	Verpackungseinheiten Kodierung HSD
on request	auf Anfrage
A,B,C,D,E,F,Z	A,B,C,D,E,F,Z

Plating Oberflächenausführung
9 = Ni
Other platings on request Andere Oberflächen auf Anfrage

HSD – Cable mount angle jack (f) 100 ohm – Cable exit down
 HSD – Kabelwinkelbuchse (f) 100 Ohm – Kabelabgang unten

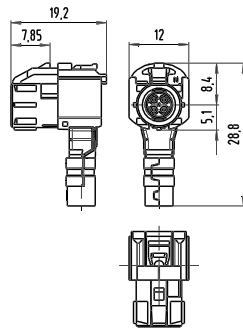
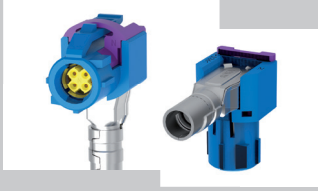

Packing Unit Coding HSD	Verpackungseinheiten Kodierung HSD
on request	auf Anfrage
A,B,C,D,E,F,Z	A,B,C,D,E,F,Z

Part No. Artikel-Nr.	Cable Group Kabelgruppe
7310.HSD.2X2D.0R	9 R (Dacar 535, 4-pole)
Please note:	<ul style="list-style-type: none"> Change the X for your required coding (page 11) As cable assembly available
Bitte beachten:	<ul style="list-style-type: none"> Das X durch Ihre gewünschte Kodierung ändern (Seite 11) Als Kabelkonfektion verfügbar
	Plating Oberflächenausführung
	9 = Ni
	Other platings on request Andere Oberflächen auf Anfrage

HSD – Cable mount angle jack (f) 100 ohm – Cable exit left
 HSD – Kabelwinkelbuchse (f) 100 Ohm – Kabelabgang links

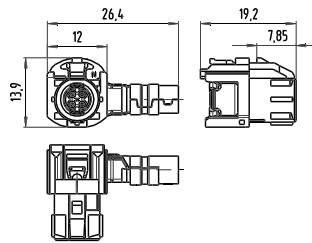
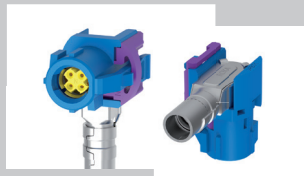

Packing Unit Coding HSD	Verpackungseinheiten Kodierung HSD
on request	auf Anfrage
A,B,C,D,E,F,Z	A,B,C,D,E,F,Z

Part No. Artikel-Nr.	Cable Group Kabelgruppe
7310.HSD.2X2L.0R	9 R (Dacar 535, 4-pole)
Please note:	<ul style="list-style-type: none"> Change the X for your required coding (page 11) As cable assembly available
Bitte beachten:	<ul style="list-style-type: none"> Das X durch Ihre gewünschte Kodierung ändern (Seite 11) Als Kabelkonfektion verfügbar
	Plating Oberflächenausführung
	9 = Ni
	Other platings on request Andere Oberflächen auf Anfrage

HSD – Cable mount angle jack (f) 100 ohm – Cable exit right
 HSD – Kabelwinkelbuchse (f) 100 Ohm – Kabelabgang rechts

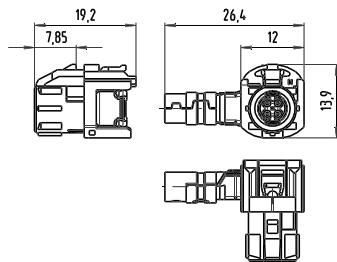
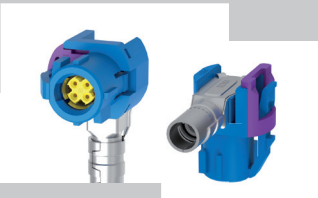

Packing Unit Coding HSD	Verpackungseinheiten Kodierung HSD
on request	auf Anfrage
A,B,C,D,E,F,Z	A,B,C,D,E,F,Z

Part No. Artikel-Nr.	Cable Group Kabelgruppe
7310.HSD.2X2R.0R	9 R (Dacar 535, 4-pole)
Please note:	<ul style="list-style-type: none"> Change the X for your required coding (page 11) As cable assembly available
Bitte beachten:	<ul style="list-style-type: none"> Das X durch Ihre gewünschte Kodierung ändern (Seite 11) Als Kabelkonfektion verfügbar
	Plating Oberflächenausführung
	9 = Ni
	Other platings on request Andere Oberflächen auf Anfrage

HSD – Cable mount angle jack (f) 100 ohm – Cable exit up
 HSD – Kabelwinkelbuchse (f) 100 Ohm – Kabelabgang oben

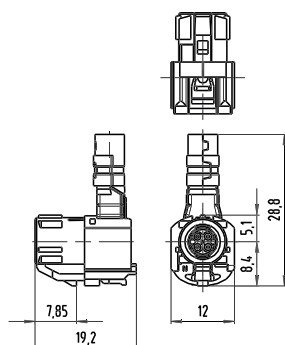
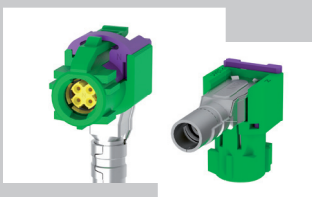

Packing Unit Coding HSD	Verpackungseinheiten Kodierung HSD
on request	auf Anfrage
G,H,J,K,L,M,O	G,H,J,K,L,M,O

Part No. Artikel-Nr.	Cable Group Kabelgruppe
7310.HSD.2X2U.0R	9 R (Dacar 535, 4-pole)
Please note:	<ul style="list-style-type: none"> Change the X for your required coding (page 11) As cable assembly available
Bitte beachten:	<ul style="list-style-type: none"> Das X durch Ihre gewünschte Kodierung ändern (Seite 11) Als Kabelkonfektion verfügbar
	Plating Oberflächenausführung
	9 = Ni
	Other platings on request Andere Oberflächen auf Anfrage

RELIABLE AND WELL-CONNECTED

The SMBA® (FAKRA) connectors are specially designed for automotive applications. They are based on the SMB connector interface and comply with the standard for a uniform connector system established by FAKRA (Automobile Expert Group). Due to their special standardized locking system

SMBA® (FAKRA) connectors fulfill the high functional and safety requirements of today's automotive industry. SMBA® coaxial connectors meet the specification of USCAR-18 and ISO 20860-1.

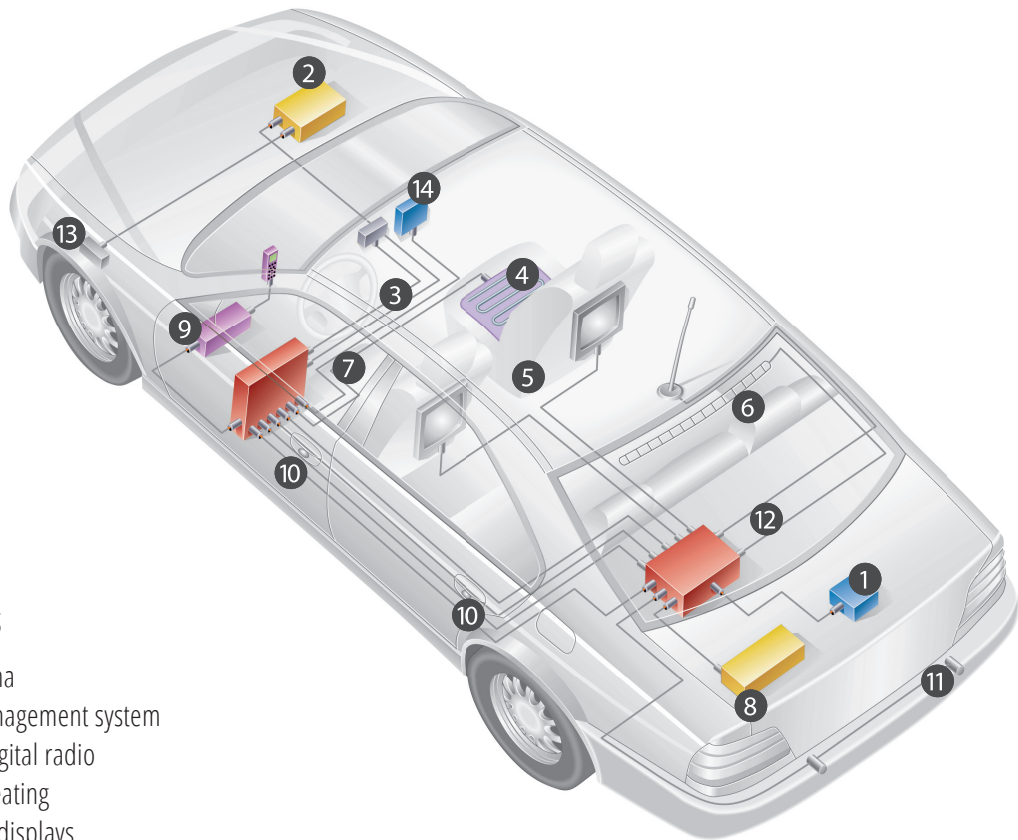

Applications

- ① GPS antenna
- ② Engine management system
- ③ Analog / Digital radio
- ④ Auxiliary heating
- ⑤ TV / Video-displays
- ⑥ Antenna
- ⑦ Distributor box
- ⑧ Accident data analysis
- ⑨ Cellular phone
- ⑩ Remote control keyless entry
- ⑪ Distance control
- ⑫ Amplifier
- ⑬ Air pressure control
- ⑭ Navigation system

Product Characteristics

- » Mature mechanical and colour coding system with 13 different codings
- » Highest possible mounting safety
- » Efficient automated capabilities for further processing
- » Rotating coaxial insert and cable in plastic housing



BENEFITS OF SMBA[®] (FAKRA) CONNECTORS

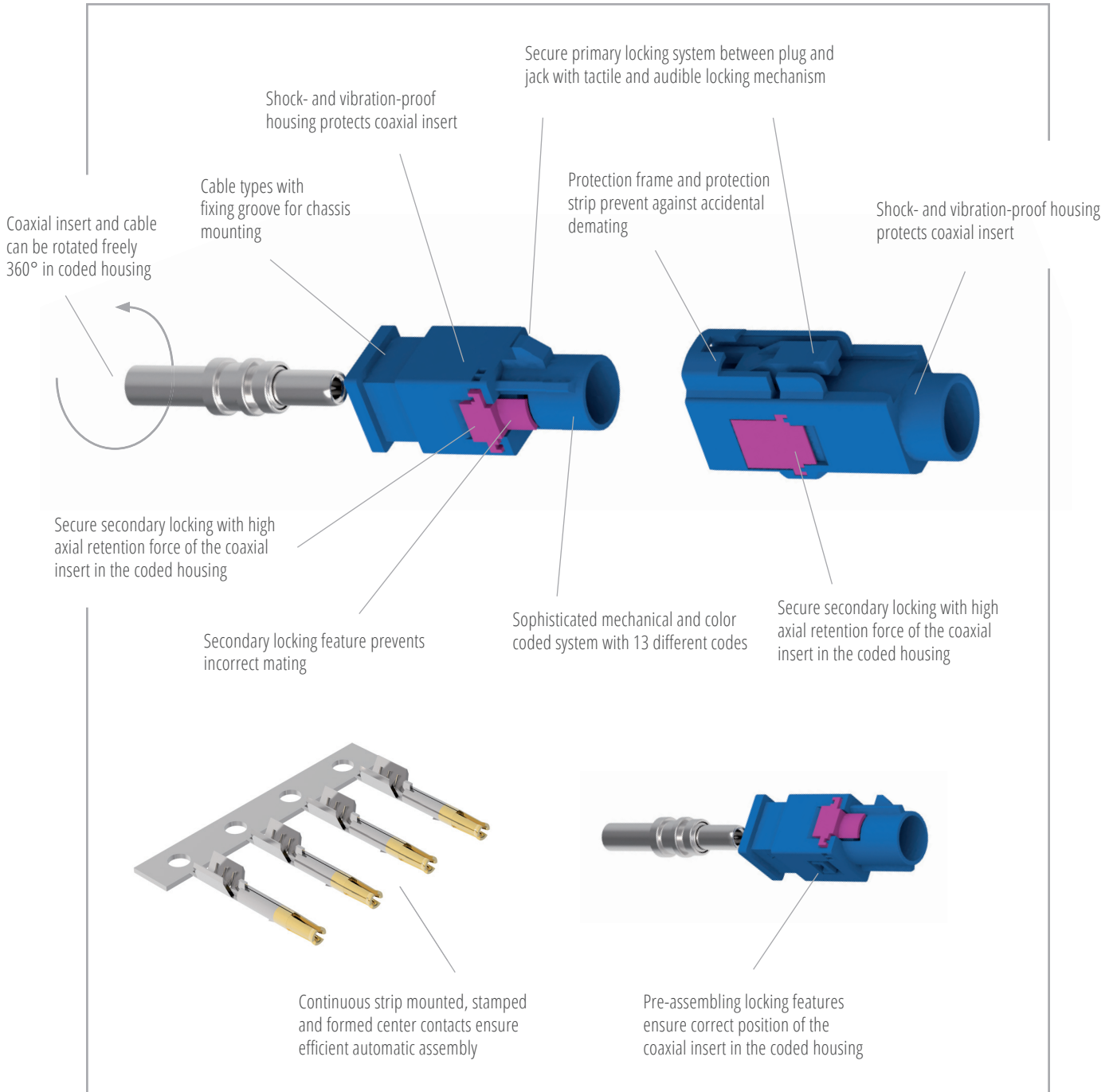

Customer-specific packaging

INTELLIGENT MOUNTING BY COLOUR CODING SYSTEM

SMBA® (FAKRA) connectors are equipped with a standardised coding system which permits easy and fast assembly using thirteen possible codings. The locking system with primary and secondary locking guarantees highest reliability of

assembly and contact. Even in vehicle areas with high stress, for example vibrations, SMBA® (FAKRA) connectors will always guarantee correct data transfer.

Jack	Application	Colour	RAL-number	Coding	Plug
	Analog radio without supply voltage	Jet black	9005	A	
	Analog radio with supply voltage	Creme-white	9001	B	
	GPS: telemetry or navigation	Signal-blue	5005	C	
	Cellular phone	Bordeaux-violet	4004	D	
	TV 1	Leaf-green	6002	E	
	TV 2	Nut-brown	8011	F	
	Remote control keyless entry	Blue-grey	7031	G	
	GPS: telemetry and navigation	Heather-violet	4003	H	
	Remote control auxiliary heating or bluetooth	Beige	1001	I	
	Radio with IF output (antenna diversity)	Curry	1027	K	
	Not defined	Carmine-red	3002	L	
	Not defined	Pastell-orange	2003	M	
	Not defined	White-green	6019	N	
	Neutral	Water blue	5021	Z	

The colours of the plastic housing are based on RAL colour codes. Slight colour variations during the production process are possible.



SMBA[®] (FAKRA) – FAMILY SPECIFICATION

Electrical characteristics		
Impedance	50	Ohm
Operating frequency	DC – 6	GHz
Return loss	≥ 18	dB typ.
Insertion loss at 4 GHz	≤ 0.1	dB
Insulation resistance	≥ 1	GOhm
Contact resistance	- Center contact - Outer contact	≤ 5 MOhm ≤ 2.5 mOhm
Withstand voltage	≥ 750	V
Operating voltage	≤ 335	V max.
Current carrying capacity	≤ 1.0	A DC
RF leakage	> 55	dB
Mechanical characteristics		
Engagement force (with or without latch)	max. 25	N
Disengagement force (without latch)	min. 2 – max. 25	N
Retention force (with latch)	min. 100	N
Mating cycles	≥ 50	
Design according to	USCAR -18, ISO 20860-1	
Materials		
Outer contact	- Male - Female	Brass Brass or Diecast
Center contact	- Male - Female	Brass Copper beryllium or Bronze
Spring washer	Stainless steel	
Insulator	PTFE / PE / SPS	
Plastic housing	PA, optional Diecast on request	
Crimp ferrule	Copper	
All products are RoHS conform.	Brass	
Standard plating: Nickel		
Outer contact	2	µm Ni min. optional Ni+Sn
Center contact	0.8	µm Au min. optional NiP+Au
Other parts	2	µm Ni min.
Alternative plating: Gold		
Outer contact	- Standard - Adapter	0.2 µm Au min. 0.8 µm Au min.
Center contact	0.8	µm Au min. optional NiP+Au
Other parts	2	µm Ni min.
Alternative plating: White bronze		
Outer contact	2 – 4	µm White bronze
Center contact	0.8	µm Au min. optional NiP+Au
Other parts	2 – 4	µm White bronze
Environmental specification		
Operating temperature range	IEC 68-2-2, -40 °C up to 105 °C	
Temperature change	IEC 68-2-14	
Vibration	IEC 68-2-64	
Humidity (cyclic)	IEC 68-8-30	
Shock	IEC 68-2-29	

Interface dimensions

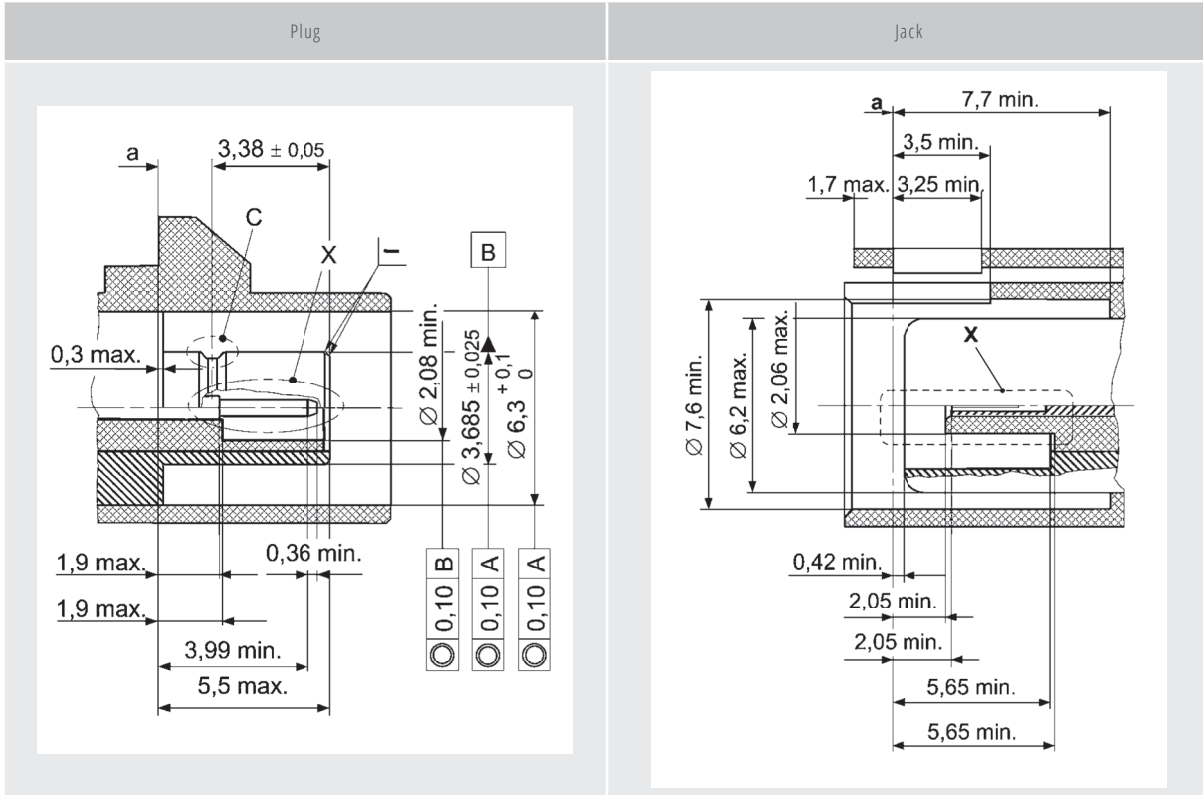

IMS Connector Systems connectors fulfill in principle the indicated technical data. Individual values of the connectors may deviate depending on applications, design, cable types and assembly methods.

Specific product data sheets for particular products can be provided on request from your IMS CS sales contact.

SMBA® (FAKRA) PCB mount plug (m) 50 ohm
SMBA® (FAKRA) Anbaustecker (m) 50 Ohm



Diecast

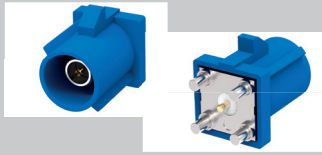

PCB-Layout

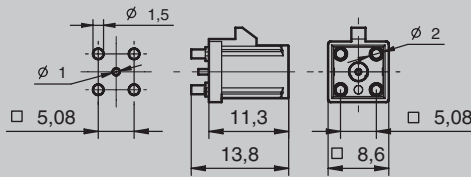

Part No.
Artikel-Nr.
4648.SMBA.1X10.00 7

Please note: Change the X for your required coding (page 20)
Bitte beachten: Das X durch Ihre gewünschte Kodierung ändern (Seite 20)

Plating
Oberflächenausführung

- 3 = NiP+Au
- 7 = Sn

Other platings on request
Andere Oberflächen auf Anfrage

SMBA® (FAKRA) PCB mount plug (m) 50 ohm
SMBA® (FAKRA) Anbaustecker (m) 50 Ohm



SMT



Diecast

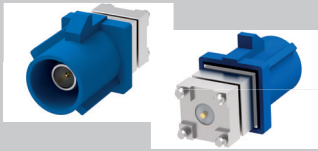

PCB-Layout

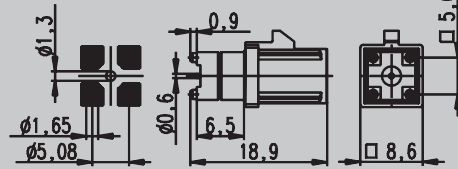

Part No. Assembly instruction
Artikel-Nr. Montageanleitung
3849.SMBA.1X10.00 9 M-176

Please note: Change the X for your required coding (page 20)
Bitte beachten: Das X durch Ihre gewünschte Kodierung ändern (Seite 20)

Plating
Oberflächenausführung

- 3 = NiP+Au
- 9 = Ni

Other platings on request
Andere Oberflächen auf Anfrage

Features Merkmale
Additional fixing optional Halteblech optional

SMBA® (FAKRA) PCB mount plug (m) 50 ohm
SMBA® (FAKRA) Anbaustecker (m) 50 Ohm



SMT



Diecast

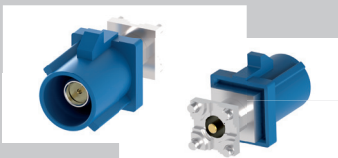

PCB-Layout

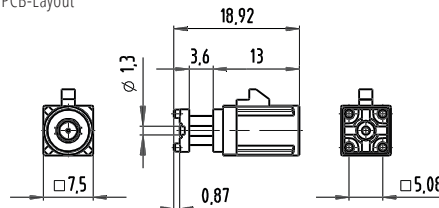

Part No.
Artikel-Nr.
4981.SMBA.1X10.00 7

Please note: Change the X for your required coding (page 20)
Bitte beachten: Das X durch Ihre gewünschte Kodierung ändern (Seite 20)

Plating
Oberflächenausführung

- 3 = NiP+Au
- 7 = Sn

Other platings on request
Andere Oberflächen auf Anfrage

SMBA® (FAKRA) PCB mount cable plug (m) 50 ohm
SMBA® (FAKRA) Kabelanbaustecker (m) 50 Ohm

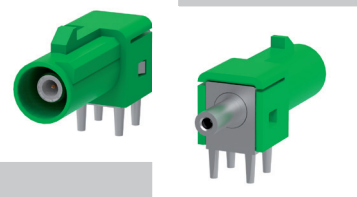

PCB-Layout

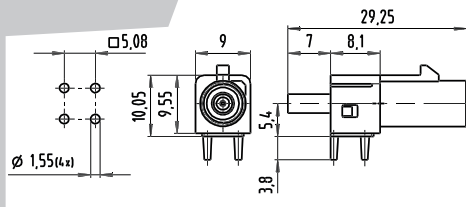

Part No. Assembly instruction
Artikel-Nr. Montageanleitung
7236.SMBA.1X20.00 7 IPEX 20278-112R-32 M-269

Please note: Change the X for your required coding (page 20)
Bitte beachten: Das X durch Ihre gewünschte Kodierung ändern (Seite 20)

Plating
Oberflächenausführung

- 3 = NiP+Au
- 7 = Sn

Other platings on request
Andere Oberflächen auf Anfrage

SMBA® (FAKRA) PCB angle plug – locking position 12:00 (m) 50 ohm
 SMBA® (FAKRA) Anbauwinkelstecker – Verriegelungsposition 12:00 (m) 50 Ohm

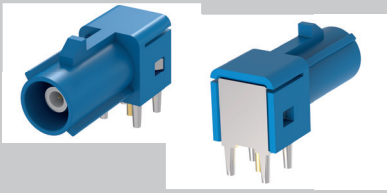

PCB-Layout

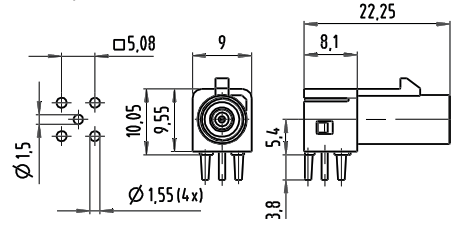

Features	Merkmale
THD – Through hole device	Durchsteckmontage
Other primary locking positions on request	Weitere Primärverriegelungspositionen auf Anfrage

Part No. Artikel-Nr.
 7249.SMBA.1X20.00 9

Please note: Change the X for your required coding (page 20)
 Bitte beachten: Das X durch Ihre gewünschte Kodierung ändern (Seite 20)

Plating
 Oberflächenausführung
 3 = NiP+Au
 9 = Ni
 Other platings on request
 Andere Oberflächen auf Anfrage

SMBA® (FAKRA) PCB angle plug – locking position 06:00 (m) 50 ohm
 SMBA® (FAKRA) Anbauwinkelstecker – Verriegelungsposition 06:00 (m) 50 Ohm

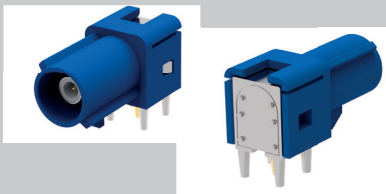

PCB-Layout

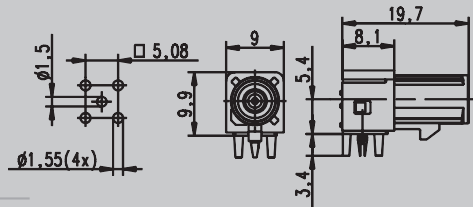

Features	Merkmale
Anti-tilt	Kippsicher
THD – Through hole device	Durchsteckmontage
Other primary locking positions on request	Weitere Primärverriegelungspositionen auf Anfrage

Part No. Artikel-Nr.
 3607.SMBA.1X20.00 9

Please note: Change the X for your required coding (page 20)
 Bitte beachten: Das X durch Ihre gewünschte Kodierung ändern (Seite 20)

Plating
 Oberflächenausführung
 3 = NiP+Au
 9 = Ni
 Other platings on request
 Andere Oberflächen auf Anfrage

SMBA® (FAKRA) PCB angle plug – locking position 12:00 (m) 50 ohm
 SMBA® (FAKRA) Anbauwinkelstecker – Verriegelungsposition 12:00 (m) 50 Ohm

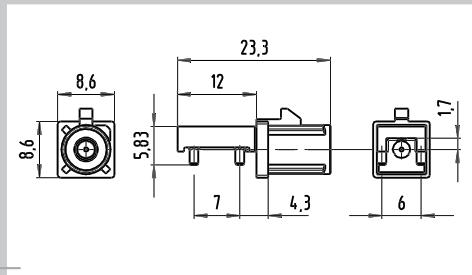
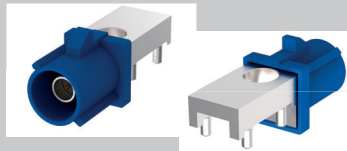

Features	Merkmale
Pin & Paste version	Pin & Paste Version
PCB Layout on request	PCB Layout auf Anfrage

Part No. Artikel-Nr.
 4989.SMBA.1X10.00 7

Please note: Change the X for your required coding (page 20)
 Bitte beachten: Das X durch Ihre gewünschte Kodierung ändern (Seite 20)

Plating
 Oberflächenausführung
 3 = NiP+Au
 7 = Sn
 Other platings on request
 Andere Oberflächen auf Anfrage

SMBA® (FAKRA) PCB angle plug – locking position 03:00 (m) 50 ohm
 SMBA® (FAKRA) Anbauwinkelstecker – Verriegelungsposition 03:00 (m) 50 Ohm

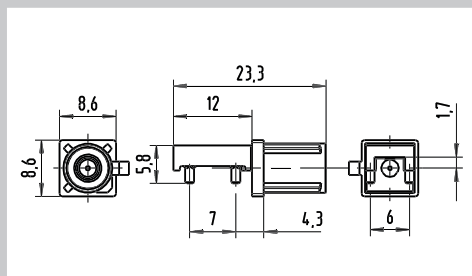
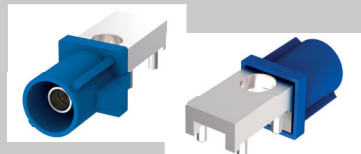

Features	Merkmale
Pin & Paste version	Pin & Paste Version
PCB Layout on request	PCB Layout auf Anfrage

Part No. Artikel-Nr.
 5063.SMBA.1X10.00 7

Please note: Change the X for your required coding (page 20)
 Bitte beachten: Das X durch Ihre gewünschte Kodierung ändern (Seite 20)

Plating
 Oberflächenausführung
 3 = NiP+Au
 7 = Sn
 Other platings on request
 Andere Oberflächen auf Anfrage

SMBA® (FAKRA) PCB angle plug – locking position 06:00 (m) 50 ohm
 SMBA® (FAKRA) Anbauwinkelstecker – Verriegelungsposition 06:00 (m) 50 Ohm



Diecast

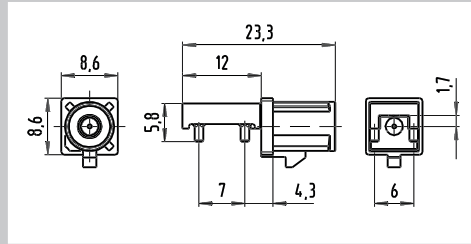
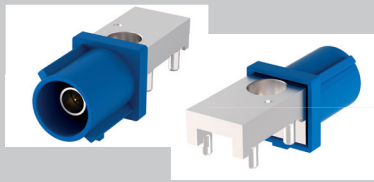

Features	Merkmale
Pin & Paste version	Pin & Paste Version
PCB Layout on request	PCB Layout auf Anfrage

Part No.
 Artikel-Nr.
 5066.SMBA.1X10.00 7

Please note: Change the X for your required coding (page 20)
 Bitte beachten: Das X durch Ihre gewünschte Kodierung ändern (Seite 20)

Plating
 Oberflächenausführung
 3 = NiP+Au
 7 = Sn
 Other platings on request
 Andere Oberflächen auf Anfrage

SMBA® (FAKRA) PCB angle plug – locking position 09:00 (m) 50 ohm
 SMBA® (FAKRA) Anbauwinkelstecker – Verriegelungsposition 09:00 (m) 50 Ohm



Diecast

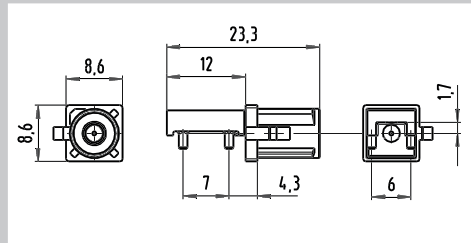
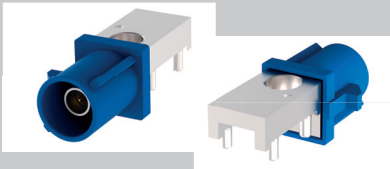

Features	Merkmale
Pin & Paste version	Pin & Paste Version
PCB Layout on request	PCB Layout auf Anfrage

Part No.
 Artikel-Nr.
 5069.SMBA.1X10.00 7

Please note: Change the X for your required coding (page 20)
 Bitte beachten: Das X durch Ihre gewünschte Kodierung ändern (Seite 20)

Plating
 Oberflächenausführung
 3 = NiP+Au
 7 = Sn
 Other platings on request
 Andere Oberflächen auf Anfrage

SMBA® (FAKRA) PCB twin angle plug – locking position 12:00 (m) 50 ohm
 SMBA® (FAKRA) Anbaudoppelwinkelstecker – Verriegelungspos. 12:00 (m) 50 Ohm



Diecast

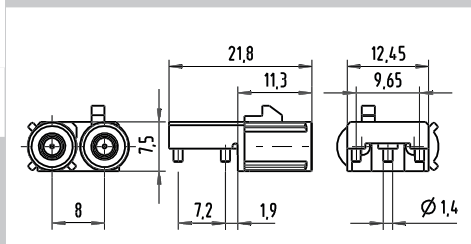
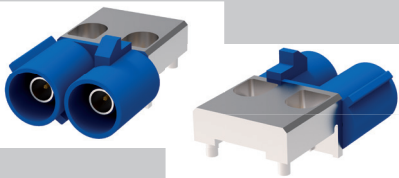

Features	Merkmale
Pin & Paste version	Pin & Paste Version
PCB Layout on request	PCB Layout auf Anfrage

Part No.
 Artikel-Nr.
 5275.SMBA.1X10.00 7

Please note: Change the X for your required coding (page 20)
 Bitte beachten: Das X durch Ihre gewünschte Kodierung ändern (Seite 20)

Plating
 Oberflächenausführung
 3 = NiP+Au
 7 = Sn
 Other platings on request
 Andere Oberflächen auf Anfrage

SMBA® (FAKRA) PCB twin angle plug – locking position 06:00 (m) 50 ohm
 SMBA® (FAKRA) Anbaudoppelwinkelstecker – Verriegelungspos. 06:00 (m) 50 Ohm



Diecast

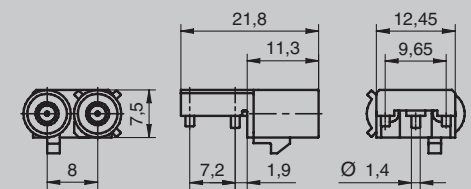
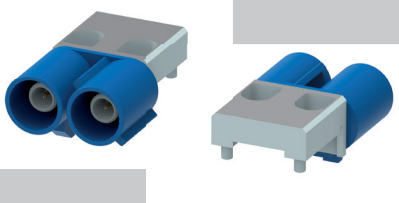

Features	Merkmale
Pin & Paste version	Pin & Paste Version
PCB Layout on request	PCB Layout auf Anfrage

Part No.
 Artikel-Nr.
 5307.SMBA.1X10.00 7

Please note: Change the X for your required coding (page 20)
 Bitte beachten: Das X durch Ihre gewünschte Kodierung ändern (Seite 20)

Plating
 Oberflächenausführung
 3 = NiP+Au
 7 = Sn
 Other platings on request
 Andere Oberflächen auf Anfrage

SMBA® (FAKRA) Cable mount bulkhead plug (m) 50 ohm
 SMBA® (FAKRA) Chassiskabelstecker (m) 50 Ohm

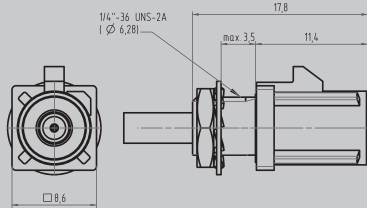
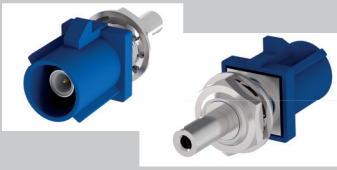

Features	Merkmale
Front mounting	Einbau von vorne
Screw-in version	Einschraub Version
Panel thickness max. 3.5 mm	Chassisstärke max. 3.5 mm

Part No. Artikel-Nr.	Cable Group Kabelgruppe	Assembly instruction Montageanleitung
4654.SMBA.1X10.04	9 4 (Hirose U.FL-2LP-066)	M-156

Please note: Change the X for your required coding (page 20)
 Bitte beachten: Das X durch Ihre gewünschte Kodierung ändern (Seite 20)

Plating Oberflächenausführung
3 = NiP+Au
9 = Ni
Other platings on request Andere Oberflächen auf Anfrage

SMBA® (FAKRA) Cable mount bulkhead plug (m) 50 ohm
 SMBA® (FAKRA) Chassiskabelstecker (m) 50 Ohm

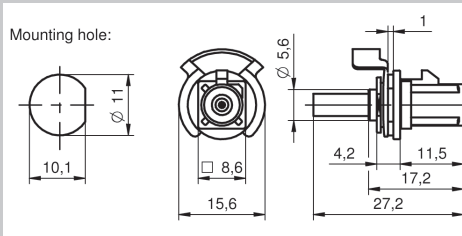

Features	Merkmale
Front mounting	Einbau von vorne
Clamp version	Federklemm Version
Panel thickness max. 1.0 mm	Chassisstärke max. 1.0 mm

Part No. Artikel-Nr.	Cable Group Kabelgruppe	Assembly instruction Montageanleitung
4610.SMBA.1X10.02	9 2 (RG 174, RG 316)	M-197

Please note: Change the X for your required coding (page 20)
 Bitte beachten: Das X durch Ihre gewünschte Kodierung ändern (Seite 20)

Plating Oberflächenausführung
3 = NiP+Au
9 = Ni
Other platings on request Andere Oberflächen auf Anfrage

SMBA® (FAKRA) Cable mount bulkhead plug (m) 50 ohm
 SMBA® (FAKRA) Chassiskabelstecker (m) 50 Ohm

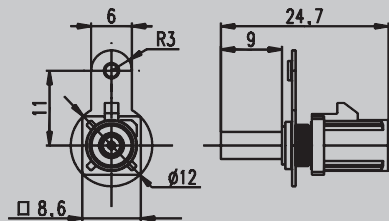

Features	Merkmale
Top mounting	Einbau von oben
Panel thickness 0.5 – 2.3 mm	Chassisstärke 0.5 – 2.3 mm
Sheet metal mounting	Blechmontage
Other individual grounding tab shapes on request	Andere individuelle Masseblechvarianten auf Anfrage

Part No. Artikel-Nr.	Cable Group Kabelgruppe	Assembly instruction Montageanleitung
3402.SMBA.1X10.01	9 1 (RG 178 B/U)	M-179
3402.SMBA.1X10.02	9 2 (RG 174, RG 316)	M-178
3402.SMBA.1X10.03	9 3 (3.2 LL)	M-178

Please note: Change the X for your required coding (page 20)
 Bitte beachten: Das X durch Ihre gewünschte Kodierung ändern (Seite 20)

Plating Oberflächenausführung
3 = NiP+Au
9 = Ni
Other platings on request Andere Oberflächen auf Anfrage

SMBA® (FAKRA) Cable mount bulkhead plug (m) 50 ohm
 SMBA® (FAKRA) Chassiskabelstecker (m) 50 Ohm

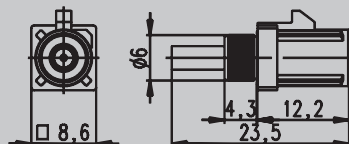
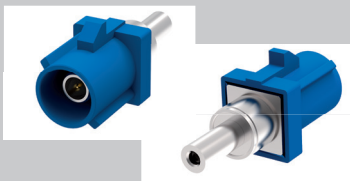

Features	Merkmale
Front mounting	Einbau von vorne
Panel thickness max. 4.3 mm	Chassisstärke max. 4.3 mm

Part No. Artikel-Nr.	Cable Group Kabelgruppe	Assembly instruction Montageanleitung
3786.SMBA.1X10.04	9 4 (Hirose U.FL-2LP-066)	M-168

Please note: Change the X for your required coding (page 20)
 Bitte beachten: Das X durch Ihre gewünschte Kodierung ändern (Seite 20)

Plating Oberflächenausführung
3 = NiP+Au
9 = Ni
Other platings on request Andere Oberflächen auf Anfrage





SMBA® (FAKRA) Bulkhead plug (m) 50 ohm
SMBA® (FAKRA) Chassisstecker (m) 50 Ohm

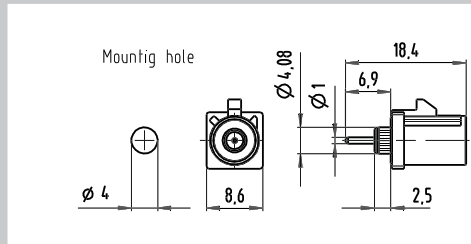
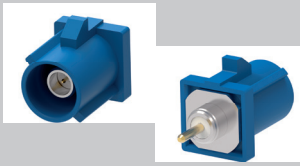

Part No.
Artikel-Nr.
6925.SMBA.1X10.00 9

Please note: Change the X for your required coding (page 20)
Bitte beachten: Das X durch Ihre gewünschte Kodierung ändern (Seite 20)

Plating
Oberflächenausführung
3 = NiP+Au
9 = Ni
Other platings on request
Andere Oberflächen auf Anfrage

SMBA® (FAKRA) Bulkhead plug (m) 50 ohm
SMBA® (FAKRA) Chassisstecker (m) 50 Ohm

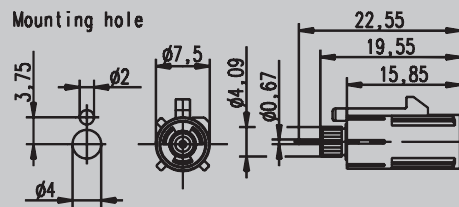
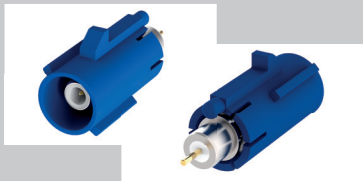

Part No.
Artikel-Nr.
3309.SMBA.1X12.00 9

Please note: Change the X for your required coding (page 20)
Bitte beachten: Das X durch Ihre gewünschte Kodierung ändern (Seite 20)

Plating
Oberflächenausführung
3 = NiP+Au
9 = Ni
Other platings on request
Andere Oberflächen auf Anfrage

Features	Merkmale
Panel thickness max. 3.5 mm	Chassisstärke max. 3.5 mm
Can be rotated 360°	360° rotierbar

SMBA® (FAKRA) Cable mount plug (m) 50 ohm
SMBA® (FAKRA) Kabelstecker (m) 50 Ohm

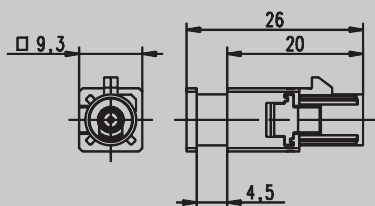
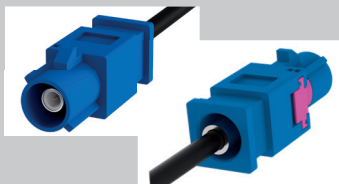

Part No. Artikel-Nr.	Cable Group Kabelgruppe	Assembly instruction Montageanleitung
4101.SMBA.1X10.02	9 2 (RG 174, RG 316)	M-193
4101.SMBA.1X10.03	9 3 (3.2 LL)	M-194
3401.SMBA.1X10.01	9 1 (ET 124899 1,2 mm)	M-156
3401.SMBA.1X10.04	9 4 (Hirose U.FL-LP-066)	M-156
3401.SMBA.1X10.08	9 8 (RG 58)	M-157
7181.SMBA.1X10.02	9 2 (1,5DS / 1,5C)	M-268

Please note: Change the X for your required coding (page 20)
Bitte beachten: Das X durch Ihre gewünschte Kodierung ändern (Seite 20)

Plating
Oberflächenausführung
9 = Ni
Other platings on request
Andere Oberflächen auf Anfrage

SMBA® (FAKRA) Cable mount plug (m) 75 ohm
SMBA® (FAKRA) Kabelstecker (m) 75 Ohm

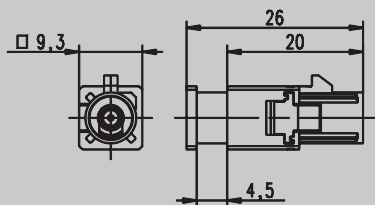
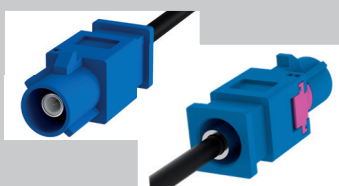

Part No. Artikel-Nr.	Cable Group Kabelgruppe	Assembly instruction Montageanleitung
7121.SMBA.1X10.08	9 8 (SYV 75-3)	M-157

Please note: Change the X for your required coding (page 20)
Bitte beachten: Das X durch Ihre gewünschte Kodierung ändern (Seite 20)

Plating
Oberflächenausführung
9 = Ni
Other platings on request
Andere Oberflächen auf Anfrage

SMBA® (FAKRA) Twin cable plug (m) 50 ohm
 SMBA® (FAKRA) Doppel Kabelstecker (m) 50 Ohm

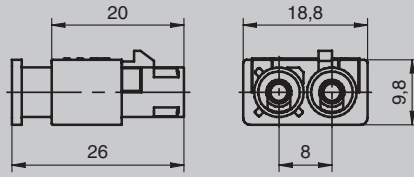
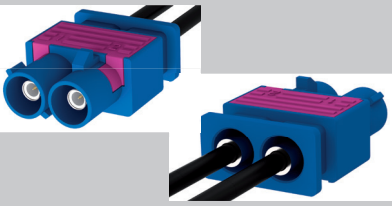

Part No. Artikel-Nr.	Cable Group Kabelgruppe	Assembly instruction Montageanleitung
4802.SMBA.1X10.02	9 2 (RG 174)	M-193
4802.SMBA.1X10.03	9 3 (3.2 LL)	M-194
7238.SMBA.1X10.02	9 2 (1,5DS / 1,5C)	M-268

Please note: Change the X for your required coding (page 20)
 Bitte beachten: Das X durch Ihre gewünschte Kodierung ändern (Seite 20)

Plating
 Oberflächenausführung

9 = Ni

Other platings on request
 Andere Oberflächen auf Anfrage

SMBA® (FAKRA) Cable mount jack (f) 50 ohm
 SMBA® (FAKRA) Kabelbuchse (f) 50 Ohm

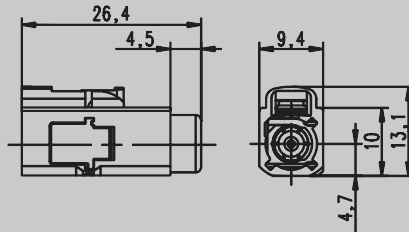
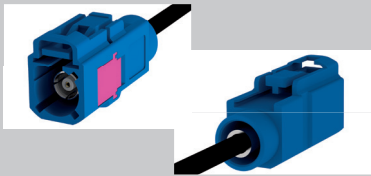

Part No. Artikel-Nr.	Cable Group Kabelgruppe	Assembly instruction Montageanleitung
3400.SMBA.2X10.08	9 8 (RG 58)	M-161
7380.SMBA.2X10.02	9 2 (RG 174)	M-191
7380.SMBA.2X10.03	9 3 (3.2 LL)	M-192
7388.SMBA.2X10.02	9 2 (1,5DS / 1,5C)	M-267

Please note: Change the X for your required coding (page 20)
 Bitte beachten: Das X durch Ihre gewünschte Kodierung ändern (Seite 20)

Plating
 Oberflächenausführung

9 = Ni

Other platings on request
 Andere Oberflächen auf Anfrage

SMBA® (FAKRA) Cable mount jack (f) 75 ohm
 SMBA® (FAKRA) Kabelbuchse (f) 75 Ohm

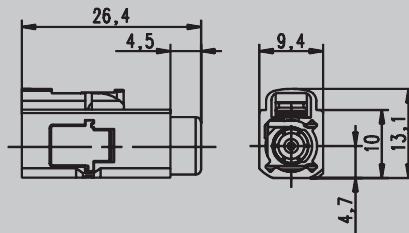
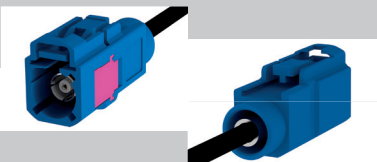

Part No. Artikel-Nr.	Cable Group Kabelgruppe	Assembly instruction Montageanleitung
7153.SMBA.2X10.08	9 8 (SYV75-3)	M-161

Please note: Change the X for your required coding (page 20)
 Bitte beachten: Das X durch Ihre gewünschte Kodierung ändern (Seite 20)

Plating
 Oberflächenausführung

9 = Ni

Other platings on request
 Andere Oberflächen auf Anfrage

SMBA® (FAKRA) Twin cable jack (f) 50 ohm
 SMBA® (FAKRA) Doppel Kabelbuchse (f) 50 Ohm

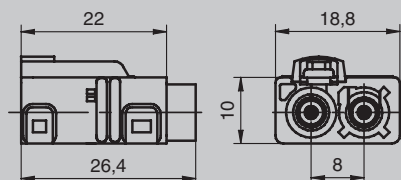
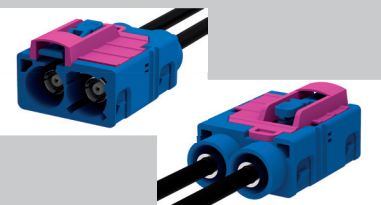

Part No. Artikel-Nr.	Cable Group Kabelgruppe	Assembly instruction Montageanleitung
4206.SMBA.2X10.02	9 2 (RG 174)	M-191
4206.SMBA.2X10.03	9 3 (3.2 LL)	M-192
7237.SMBA.2X10.02	9 2 (1,5DS / 1,5C)	M-267

Please note: Change the X for your required coding (page 20)
 Bitte beachten: Das X durch Ihre gewünschte Kodierung ändern (Seite 20)

Plating
 Oberflächenausführung

9 = Ni

Other platings on request
 Andere Oberflächen auf Anfrage

SMBA® (FAKRA) Cable mount angle jack (f) 50 ohm
 SMBA® (FAKRA) Kabelwinkelbuchse (f) 50 Ohm

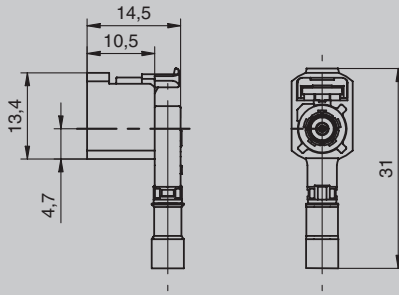

Part No. Artikel-Nr.	Cable Group Kabelgruppe	Assembly instruction Montageanleitung
4102.SMBA.2X20.02	9 2 (RG 174, RG 316)	M-196
4102.SMBA.2X20.03	9 3 (3.2 LL)	M-248

Please note: Change the X for your required coding (page 20)
 Bitte beachten: Das X durch Ihre gewünschte Kodierung ändern (Seite 20)

Plating
 Oberflächenausführung

9 = Ni

Other platings on request
 Andere Oberflächen auf Anfrage

SMBA® (FAKRA) Twin cable mount angle jack (f) 50 ohm
 SMBA® (FAKRA) Doppel Kabelwinkelbuchse (f) 50 Ohm

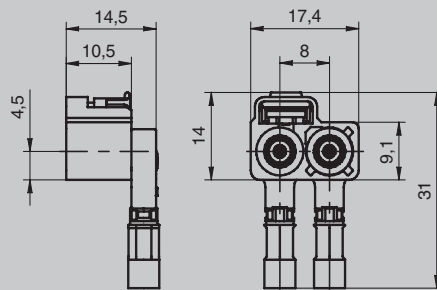

Part No. Artikel-Nr.	Cable Group Kabelgruppe	Assembly instruction Montageanleitung
4803.SMBA.2X20.02	9 2 (RG 174)	M-196
4803.SMBA.2X20.03	9 3 (3.2 LL)	M-248

Please note: Change the X for your required coding (page 20)
 Bitte beachten: Das X durch Ihre gewünschte Kodierung ändern (Seite 20)

Plating
 Oberflächenausführung

9 = Ni

Other platings on request
 Andere Oberflächen auf Anfrage

SMBA® (FAKRA) – SMA Testadapter (f-f) 50 ohm
 SMBA® (FAKRA) – SMA Testadapter (f-f) 50 Ohm

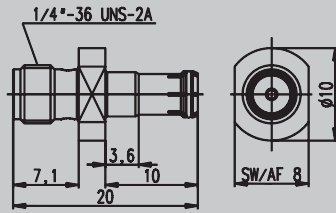
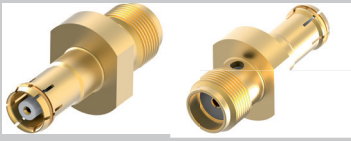

Part No.
 Artikel-Nr.
 3548.SMBA.9910.00 1

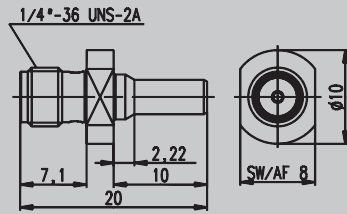
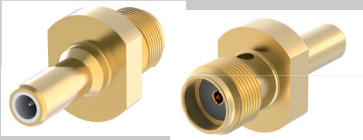

Plating
 Oberflächenausführung
 1 = Au
 Other platings on request
 Andere Oberflächen auf Anfrage

SMBA® (FAKRA) – SMA Testadapter (m-f) 50 ohm
 SMBA® (FAKRA) – SMA Testadapter (m-f) 50 Ohm

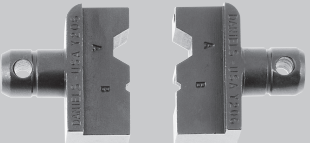

Part No.
 Artikel-Nr.
 3549.SMBA.9910.00 1

Plating
 Oberflächenausführung
 1 = Au
 Other platings on request
 Andere Oberflächen auf Anfrage

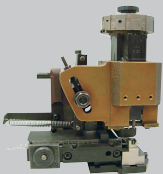
Kabeltyp Cable type	Plug straight Stecker gerade				Jack straight Buchse gerade			Plug 90° angle Stecker 90° gewinkelt	
	1 (ET 124899)	2 (RG 174)	3 (RTK 031)	8 (RG 58)	2 (RG 174)	3 (RTK 031)	8 (RG 58)	2 (RG 174)	3 (RTK 031)
4 (Hirose U.FL.- LP-066)									
Part No. Artikel-Nr.	3401.SMBA.1X10.0X9	4101.SMBA.1X10.029	4101.SMBA.1X10.039	3401.SMBA.1X10.089	4100.SMBA.2X10.029	4100.SMBA.2X10.039	3400.SMBA.2X10.089	4102.SMBA.2X20.029	4102.SMBA.2X20.039
Tools for other products on request. Werkzeuge für weitere Produkte auf Anfrage.									
Hand crimp tool without inserts Handcrimpwerkzeug ohne Einsätze									
	AGK-2365			AGK-2365			AGK-2365		
Inserts for hand crimp tool Crimpeinsätze für Handcrimpwerkzeug									
	AGK-3573-10			AGK-3573-14			AGK-3573-14		
Hand crimp tool with inserts for outer contactor Handcrimpwerkzeug mit Einsätze für Außenleiter									
	AGK-4046	AGK-4046		AGK-4046	AGK-4046		AGK-4077	AGK-4078	
Hand crimp tools B-crimp for center contactor Handcrimpwerkzeug für B-Crimp des Innenleiters									
	AGK-4045	AGK-4044		AGK-4045	AGK-4044		AGK-3763		
Semi-automatic crimp tools for B-crimp Halbautomatisches Crimpwerkzeug für B-Crimp									
	AGK-4086	AGK-4087		AGK-4086	AGK-4087		AGK-3803	AGK-4016	AGK-4015

Erzeugnis / Product: **FAKRA-Stecker**
FAKRA connector, male
 Kabeltyp / Cable-type: **"Low loss 3,2mm"**

Variable	Cable typ	L1	L2	L3
4	AKR-3573-10	2,4	5	9,7

Stripping as shown in picture, according to the dimensions in the table. Please take care, do not damage conductor.

Lay shielding over the crimpneck and fit the cable centre conductor in possible position. Be careful in handling of the cable shielding and cable conductor. Crimp the conductor. Size shown in the table (below). Push the contact pin with the square shielding. Crimp the ferrule with the hex. size shown in the table (below).

Carefully press in the mounted connecting piece into the housing.

Variable	Cable typ	Outer Contact hex-Crimp size	length	Inner contact squ-Crimp size	length	Crimp die MS-number
4	AKR-3573-10	2,67	6	1,23	1,5	AKR-3573-10

a. Kabelstufung entspr. Abb. herstellen
 Strip the cable acc. to the drawing
 b. Kontakt (1) an Innenleiter crimpen
 Crimp the ferrule (1) on the inner conductor
 c. Crimprohr (2) auf das Kabel schieben
 Push the crimping tube (2) over the cable
 d. Schirmgeflecht und -falle an der Stirnseite
 kleben und mit einem Stripsen
 e. Kabel in den vorst. Stecker (3) bis zum
 Push the cable into the pre-assembled connector (3) up
 f. Crimprohr (2) bis zum Anschlag an den Stecker (3) schieben
 Push the crimping tube up to the connector
 g. Schirmverriegelung entspr. Abb. herstellen
 Do the hexagon crimping acc. to the drawing
 h. Stecker in das Steckergehäuse (4) einstecken bis die Primärverriegelung
 einrastet
 Insert the connector into the housing (4) until the primary lock snaps in
 i. Sekundärverriegelung (5) einrasten
 Snap the secondary lock (5) in

For more information please visit our website:
www.imscs.com >> Products >> eCatalog

Here you'll find further product specific documents available for download:

- » drawings
- » specifications
- » assembly instructions
- » STEP-files

IMS CONNECTOR SYSTEMS – WORLDWIDE



IMS CS GmbH | Löffingen, Germany



IMS CS Inc. | Dallas, United States

Thanks to subsidiaries and distribution partners worldwide, IMS Connector Systems offers a fast and optimum support to its global customers.

IMS CS, headquartered in Germany, maintains its global footprint through production facilities in Europe and Asia, as well as sales offices and channel partners throughout the world.

- Headquarters
- Production plants
- Sales subsidiaries





IMS CS Kft. | Sopron, Hungary

IMS CONNECTOR SYSTEMS



TOB IMC KOHHEKTOP CICTEMC | Csepe, Ukraine



IMS CS Ltd. | Suzhou, China





EUROPE

IMS Connector Systems GmbH
Obere Hauptstraße 30
DE-79843 Löffingen

Phone (+49) 7654 901-100
Fax (+49) 7654 901-199
sales@imscs.com

AMERICAS

IMS Connector Systems Inc.
22305 Golden Canyon Circle
Chatsworth
US-CA 91311

Phone (+1) 214 704-1115
salesusa@imscs.com

APAC

IMS Connector Systems Ltd
No 35, Huo Ju Road
SND Science & Technology Park
CN-Suzhou 215011

Phone (+86) 512 6808-1816
Fax (+86) 512 6825-2388
sales@imscscn.com

IMS CONNECTOR SYSTEMS

HEADQUARTERS, GERMANY
IMS Connector Systems GmbH
Obere Hauptstraße 30
DE-79843 Löffingen

Phone (+49) 7654 901-100
Fax (+49) 7654 901-199

sales@imscs.com
www.imscs.com

More product information:
www.imscs.com >> Markets >> Automotive

